

TRIDON

MEGA TOOLS SALE

1 OCTOBER - 31 DECEMBER 2021 • ALL PRICES INCLUDE GST • WHILE STOCKS LAST

CRAZY PRICE!

\$42.95



MATSON

Bluetooth® Vehicle Monitor MA98414

- Real-time digital dashboard of vehicle conditions
- Monitor speed, RPM, battery voltage, engine temp etc
- Monitor fuel consumption and driving behaviour
- Diagnostic function to scan, read and clear fault codes



NEW PRODUCT

\$407.95

FAMOUS TOLEDO

Circuit Tester Professional Multi-Function 302193 12-24 Volt

- Large high resolution screen for easy readout
- Supplies power and ground for functional component testing
- Suitable for voltage and polarity testing, continuity testing, activating components in or out of the vehicle
- Retains min/max values
- Bright LED torch feature for use in low light situations



NEW PRODUCT

\$116.95

Bikeservice

Tyre Inflator BS70010 with Dual Gauge

- Three stage control of measurement for inflation and deflation
- Dual pressure analogue display, kPa & PSI.
- 2" pressure gauge with rubber cover
- Working pressure 0- 700kPa (100psi)
- 1/4" NPT air inlet



BONUS PACK

\$164.95

Sykes-Pickavant

Thread File Set SBP027 4 Piece

- For the restoration of damaged or worn threads
- For where conventional dies cannot be used
- Left and right hand thread applications
- Provides eight different pitch sizes
- BSW/BSF, SAE/UN, Metric, BSP
- File Length: 75mm
- Overall Length: 215mm
- Made in England



BONUS PACK



FREE

Sykes-Pickavant Collapsible Magnetic Parts Tray 135mm

Part No. 680001

\$7.95



FAMOUS TOLEDO

Gasket Scraper 301007 280mm

- Blade width: 25mm

\$24.95

TRIDON

Cable Tie Pack CTP25 1000 Cable Ties

- Assorted colours
- Size Range: 100 - 200mm
- Manufactured from virgin nylon 6/6 and are UL94V-2 flammable rated



\$84.95



FAMOUS TOLEDO

Universal Spanner Extender 321045 340mm

- Minimises slippage and provides additional leverage when removing stubborn nuts and bolts
- Features 1/2" square drive adaptor for increased leverage
- Made in Germany

BONUS PACK

\$599.95

MATSON

180 Watt Folding Solar Panel MABP026

- IP67 Waterproof regulator included
- Lightweight and flexible
- Portable folding panel
- Ideal power source for all kinds of camping and outdoor activities



Part No. MA1101



VALUED AT \$59.99 RRP (MSRP)

Part No. MA98412

FREE Bluetooth® Battery Monitor

NEW PRODUCT

\$19.95

MATSON

12V Battery Monitor MA98416

- DIY install in 2 minutes
- Bright colour coded LEDs indicate battery voltage
- Easily visible from metres away
- Fast, accurate and reliable
- Water and dust proof to IP67



NEW PRODUCT

\$60.00



KNIPEX

CutiX Universal Knife 90 10 165 BK 165mm

- Exert targeted pressure on the back of the blade without risk of injury, no unintentional bending or breaking of the blade
- Durable magnesium housing: as light as plastic, strong as die-cast aluminium
- High quality snap-off blades with two spare blades in the handle drawer which can be changed without any tools
- Suitable for standard 18 mm blade types: smooth, curved and with hooks
- Fits comfortably in the hand due to its slim shape and numerous grip zones: firm and non-slip grip, comfortable hold
- Made in Germany

BONUS PACK

\$220.00

BONUS PACK

KNIPEX

Heavy Duty Power Pack KBP074 3 Piece

- Contains three popular KNIPEX pliers with FREE Mini Cobra®
- Made in Germany

Part No.	Description	Length mm
87 02 250	Cobra® HighTech Water Pump Plier	250
74 02 200	High Leverage Diagonal Cutter	200
02 02 200	High Leverage Combination Plier	200
87 01 125	FREE Cobra® Water Pump Plier	125



FREE

KNIPEX Cobra® Water Pump Plier 125mm



\$21.95

FAMOUS TOLEDO

Circuit Tester 302144 6-24V (DC)

- Heavy duty circuit testing tool
- High impact transparent handle, steel probe, replaceable bulb, strain relief spring lead design and crocodile clip
- Lead Length: 1500mm
- Probe Length: 100mm





MEGA

FAMOUS TOLEDO
EXCELLENCE BY DESIGN

TOLEDO TOOL SPECIALS - TOLEDO TOOL SPECIALS - TOLEDO TOOLS

Stainless Steel Rules

- Single sided
- Manufactured from high grade stainless steel
- Made in Japan

\$7.95 FROM

Part No.	Length	Graduations	PRICE
150BM	150mm	Upper Edge: 1mm Lower Edge: 0.5mm	\$7.95
300M	300mm	Upper Edge: 1mm Lower Edge: 0.5mm	\$15.95
600M	600mm	Upper Edge: 1mm Lower Edge: 0.5mm	\$29.95
1000M	1000mm	Upper Edge: 1mm Lower Edge: 0.5mm	\$56.95

Automatic Self Grip Pullers

- Quick change head design allows for 2 or 3 jaw external or internal pulling work
- Ensures maximum grip for all pulling applications
- Easy removal of bearings, pulleys, gears and sprockets

\$130.95 FROM

Part No.	Size	Spread	Reach	Capacity	PRICE
225040	4"	76-102mm	90mm	10 Tonne	\$130.95
225070	7"	76-178mm	135mm	20 Tonne	\$252.95

Slide Hammer Puller Set Front & Rear Hub 245300 2.3kgs

- Multi-purpose design for removal of front and rear hubs, bearing oil seal bushes and flange type axles
- Includes slide hammer with multiple attachments including 2 and 3 jaw internal and external puller, front and rear hub pullers and various accessories

\$188.95

Pilot Bearing Puller 245464 3 Jaw Mechanical

- Compact internal pilot bearing puller designed to extract flywheel spigot bearings
- Suitable for removing spigot bearings, alternator and pump bearings etc.
- Adjustable support legs with locking screws
- Internal diameter range: 13-45mm

\$60.95

Harmonic Balancer Master Puller Set 254230

- Comprehensive multi-purpose puller set designed for the removal of harmonic balancers, timing gears and pulleys where access to 2 or 3 tapped holes is available

\$41.95

Hydraulic Bearing Puller Set 265000 Master Kit

- Universal master kit for various applications
- Includes 75-105mm bearing separator
- Supplied in a blow mould storage case
- Capacity: 10 tonne
- Spread: 180mm
- Reach: 425mm

\$365.95

Hydraulic Ram & Nose Piece 265100 10 Tonne

- Overall Length: 160mm
- Width: 35mm
- Thread Size: 1 1/2" - 16TPI

\$140.95

Cleaning Brush Set 301003 3 Piece

- Multi-purpose three piece brush set comprising one brush each of nylon, brass and steel bristles

\$5.95

Parts Cleaning Brush 301004

- Ideal for cleaning engine and transmission spares, brake parts and bearings
- Strong and durable bristles with heavy duty nylon handle

\$4.95

Magnetic Pick Up Tools

- Telescopic body for adjustable reach
- Strong magnetic power for firm retrieval and pick-up of ferrous material
- Manufactured from durable stainless steel

Part No.	Telescopic Range	Magnet Size	Magnet Capacity	PRICE
301014	150 - 670mm	Ø 6mm	200g	\$10.95
301019	125 - 640mm	Ø 13mm	2.5kg	\$16.95
301298	170 - 760mm	Ø 7mm	700g	\$18.95
301299	170 - 760mm	Ø 13mm	3.6kg	\$21.95

Oil Seal Remover 301042 310mm

- Removes seals on various applications including auto, industrial and marine etc
- Includes replacement hook tip and screws

\$18.95

Pick & Hook Set 301043 Miniature 130mm 4 Piece

- Ideal for scraping, scribing, marking, picking and seal removal

\$14.95

Thread Files

- Restore damaged, worn or corroded threads
- For left and right handed threads

Part No.	Thread Pitch Range	Type	PRICE
301065	0.80, 1.00, 1.25, 1.50, 1.75, 2.00, 3.00mm	Metric	\$47.95 EACH
301066	10, 11, 12, 14, 16, 18, 20, 24 (TPI)	Imperial	\$47.95 EACH

Dead Blow Hammers

- Hollowed cylindrical heads containing steel pellets offering a dead blow and impact with the rise and fall of the hammer
- Non sparking and marring
- Shockless and non-bound
- Nitrile chemical resistance rubber material with a moulded handle

\$26.95 FROM

Pry Bar Set 301083 Standard 4 Piece

- Workshop essential set of pry bars manufactured from high quality alloy steel with black phosphate finish for strength and durability with ergonomic plastic handles
- Length: 200, 300, 450, 600mm

\$39.95

Impact Driver, Multi-Bit 301095 1/2" Sq. Drive 5 Piece

- Delivers strong rotational force and forward thrust with a strike of a hammer
- Suitable for removing large screws or bolts that are seized or over torqued
- Applicable for right or left hand threads
- Phillips: P#2 & P#3
- Slotted: SL8 & SL10

\$54.95

Spanner Rack Organiser 301108 15 Piece 300mm

- For offset and open end or combination spanners
- High impact plastic with inbuilt eyelet for wall mount
- Neatly store open end, ring or combination spanners

\$8.95

Torque Wrenches

- Click-stop style design with heavy duty cam
- Robust slim style, reversible 24 tooth ratchet head and security locking handle mechanism for heavy duty applications
- Ideal for automatic transmission service

\$74.95 FROM

Part No.	Length	Dual Scale	Sq. Drive	PRICE
301099	470mm	14-203 Nm/10-150 ft.lbs	1/2"	\$74.95
301349	675mm	68-406 Nm/50-300 ft.lbs	3/4"	\$198.95

Hose Remover Set 301151 2 Piece

- Specifically for manipulating the seal when removing or working with hoses

\$13.95

Feeler Gauges

- Manufactured from high quality steel for strength, durability and accuracy
- Designed for measurement of small gaps, ideal for use in engineering and automotive applications

Part No.	Description	Size Range	PRICE
301155	35 steel blades and 3 brass blades	0.038 (0.0015") - 0.889mm (0.035")	\$13.95 EACH
301157	26 cranked (45°) steel blades	0.127mm-0.762mm/0.005"-0.030"	\$13.95 EACH

Razor Style Long Reach Scraper 301247 6 Piece 280mm

- Special tool designed for scraping windows and glass
- Also ideal for scraping paint from mirrors, tiles and other flat surfaces
- Blade width: 40mm

\$12.95

Plastic Pipe Cutter 301028 Heavy Duty

- Cuts rubber heater hose, airline hose, PVC and vacuum tubing up to 42mm
- Not suitable for metal cutting

\$25.95

TOOL SALE

FAMOUS TOLEDO
EXCELLENCE BY DESIGN

TOLEDO SPECIALS · TOLEDO TOOL SPECIALS · TOLEDO TOOL SPECIALS

NEW PRODUCT

\$195.95

Deburr Tool Set

301562 3 Piece Internal & External

- Ideal for chamfering sharp edges on pipes, tubes, rods and repair threads on fasteners, bolts, studs and threaded rods etc
- Range: Ø3 to 35mm



NEW PRODUCT

\$50.95

Precision Screwdriver Set

301563 12 Piece

- Professional precision screw drivers for removing and installing micro screws
- Precision tips allows fastening on delicate electronic components and fine tuning
- Comfortable ergonomic handle with free spinning end cap for smooth fine tuning
- Manufactured from alloy steel shaft for strength and durability
- Size: SL1, SL1.5, SL2, SL2.4, SL3, SL3.5, SL4, P#000, P#00, P#0, P#1, P#2
- **NOTE: Do not use for prying**



\$72.95

Flaring Tool

301701 Double Lap

- For copper, brass, mild steel and aluminium tubing
- Suitable for creating single and double lap flares in sizes 4.75, 5, 6, 8, and 10mm
- Includes a mini tube cutter capable of cutting plastic, brass, copper, aluminium and mild steel tubing



NEW PRODUCT

\$206.95



Nut Riveter Hand Tool Kit

- Specialty tool for setting rivet nut fastenings
- Suitable for automotive, metal fabrication work, industrial and construction applications
- Equipped with nose piece and mandrels for secure installation of rivet nut fasteners
- Replacement rivet nut fasteners available



\$17.95

Pick-Up Tool

301697 Clam Style 700mm

- Flexible shaft with spring loaded extendable retrieval claw function
- Probe Ø: 7mm
- Head Ø: 15mm
- Claw Opening (Max.): 25mm

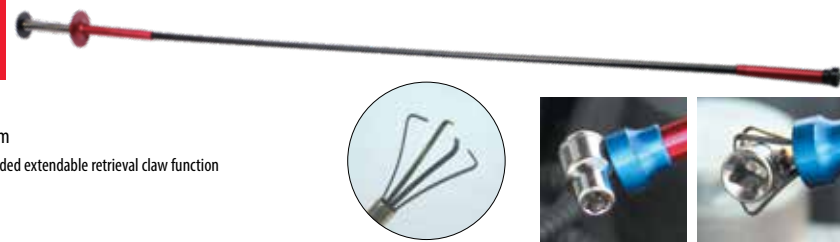

\$5.95

Alloy Wheel Cleaning Brush

301909

- Durable non-scratch soft bristle
- Bendable for hard to reach areas



\$141.95

Circlip Plier Set

301939 Quick Conversion 10 Piece

- Comprehensive set for removal and installation of internal and external circlips
- Thumb screw quick conversion style
- Includes pick and hook tools



Easy Pick Up Rules

Stainless Steel Single Sided

- Easy pick-up rules feature a bent edge at one end to enable user to easily pick-up the rule
- **Made in Japan**

Part No.	Length	Width	PRICE
301956	150mm	15mm	\$7.95
301957	300mm	25mm	\$15.95



Multi-Grip Pliers

- For gripping, holding and clamping
- Adjustable jaw openings
- Gripping zones for flat and round material

Part No.	Length mm	Jaw Opening	Jaw Width	PRICE
301998	250mm	0-35mm	8mm	\$36.95
301999	300mm	0-60mm	9mm	\$44.95



\$190.95

Multi-Head Ratchet Crimper

302018 220mm

- Crimping plier kit for various automotive terminals
- Suitable for ignition leads, engine wiring harness, power cables, speaker and AV cables and etc
- Seven interchangeable crimp dies and one ratcheting crimper

WHILE STOCKS LAST!

\$76.95



OBDDII EOBDD & CAN Code Reader

302200

- Retrieves generic fault codes P0, P2, P3 and U0 including manufacturer specific codes P1, P3 & U1 and pending codes
- Features one click quick function key for emission readiness check, live data check, default datastream check and DTC check
- Large 2.0" TFT colour display and LED indicators with built in speaker for audible tone and readiness verification
- Updated with the latest software version to suit most popular vehicles in the Australian/New Zealand market
- Resets and clears check engine light codes (MIL), views freeze frame data and vehicle identification number readout (VIN)
- Applicable for vehicles from 1996 and later with OBDDII/EOBDD or CAN

\$176.95

Compression Tester Kit

304175

Petrol 300PSI

- A genuine professional mechanics petrol compression tester supplied in heavy duty case with foam inlay
- Dual calibrated gauge, stainless steel braided high pressure hose with adaptors
- Sizes: M10, M12, M14, M16



NEW PRODUCT

\$15.95

Valve Spring Compressor Tool

304054 GM V8 LS

- Essential tool when removing and installing valves



NEW PRODUCT

\$110.95

Flywheel Locking Tool

304203 Ford

- For the locking of the fly wheel during engine servicing and repairs
- Includes 3 different side adaptors
- Suitable for various Ford models with petrol and diesel engines



\$664.95

INCLUDES APPLICATION LIST AND USER GUIDE



Compression Tester Master Kit

304600 Diesel 1000PSI

- Professional master compression tester kit for diagnosis of compression related problems on diesel engines
- Comprehensive kit includes liquid filled dual scale gauge (1000psi/70bar) with a wide range of glow plug adaptors, dummy injectors and a universal clamp/adaptor set
- Covers most of the Australian car parc

NEW PRODUCT

\$558.95

Cylinder Bore Gauge

304998 50-160mm

- Professional tool for measuring internal diameter of cylinder bores
- Essential for engine rebuilding and modifications
- Check for taper, out of round and oversize measurements
- Includes dial gauge, extension grip, shims and various size anvils
- Hardened steel needles with hardness 62-64HRC and chrome hardened steel probe with hardness HV1000
- Increments: 0.01mm
- Depth: 150mm





FAMOUS TOLEDO
EXCELLENCE BY DESIGN

MEGA

TOLEDO TOOL SPECIALS - TOLEDO TOOL SPECIALS - TOLEDO TOOLS

\$25.95

Oil Filter Remover

305021 3 Jaw

- Adjustable 3 jaw oil filter remover suitable for 60-120mm diameter filters
- Includes 1/2" to 3/8" square drive reducer adaptor



\$8.95

Brake Bleeder Kit

310261 One Man

- For carrying out one man brake bleeding operation on passenger cars, light commercials and motorcycles
- Powerful magnet to secure bottle hands free, three nylon adaptors to fit all brakes and plastic bottle for discharged fluid collection



\$141.95

Syringe for Fuel Filling/Extraction

305156 1.5L

- Designed for Petrol and Diesel fuel filling and extraction
- Manufactured from fuel resistant materials
- Easy to dismantle for cleaning
- Supplied with quick release connectors to suit most vehicles
- Open/close twist valve is easy to use and prevents overflowing and spillage

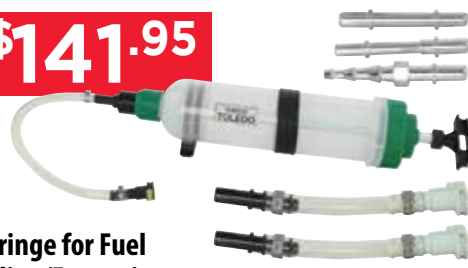

\$10.95

Oil Filter Remover

305211 Nylon Strap 1/2" Sq. Dr

- Sturdy non-slip nylon strap for spin-on type filters of up to 150mm(6") in diameter
- Width: 50mm



\$64.95

Universal Funnel

305080

- Unique universal clamp design provides effective and mess free filling of fluids into engines, containers, drums and barrels
- Adjustable clamp range: 28-74mm



\$60.95

Portable Bearing Packer

305150 95mm

- Simply insert bearing in the bearing packer, connect grease gun to nipple and old grease is forced out and evenly replaced with fresh grease
- Bearing range: Ø 50 - 95mm O.D
- Bearing height (Min.): 20mm

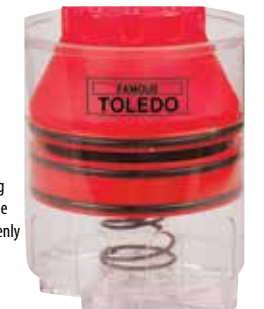

\$66.95

Spray Cleaning Gun

305165 Flexible Hose 320mm

Pneumatic 1 Litre

- Flexible head allows for deep cleaning in hard to reach areas
- Use with engine degreaser and non flammable solvents



\$17.95 FROM

Oil Measuring Containers

- Suitable for use with non-corrosive liquids
- Detachable flexible spout and cover lid for easy pouring



Part No.	Capacity	PRICE
305214	1 Litre	\$17.95
305264	5 Litre	\$23.95

\$7.95

Oil Seal Pick Set

301297 2 Piece

- Handy double ended two piece set designed for easy removal of oil seals and O-rings
- Stainless steel shaft with plastic knurled grips



\$51.95

Stock Knife

SK5 Single Blade

- High grade stainless steel
- Improved quality



Blade Length	Overall Length
100mm	225mm

\$109.95

Coolant Filter Funnel Set

305092

- Universal funnel for refilling cooling system and assisting in bleeding air
- Fits directly onto filler neck or expansion tank
- Features convenient tap to prevent spilling
- Includes five adaptors to suit most vehicles (31, 35, 40, 42, 45mm)



\$88.95



\$44.95



Fluid Change Syringes

- For neat, clean and accurate fluid suction and dispensing
- Suitable for engine oil, gear oil, differential oil etc
- Replacement seal kits available

Part No	Capacity	Extension Hose	PRICE
305151	1.5 Litre	400mm	\$88.95
305152	200ml	200mm	\$44.95



Pump Up Pressure Sprayers

- Pump action pressure sprayer with heavy duty viton seals
- Ideal for most workshop liquids and solvents
- Adjustable nozzle from mist to direct jet spray pattern

Part No.	Working Pressure	Capacity	PRICE
305153	50-70psi	1 Litre	\$36.95
305154	50-70psi	2 Litre	\$46.95

\$85.95



Sandblasting Gun

305166 1 Litre

- Effective way of removing contaminants on hard surfaces such as rust, paint and lacquer or to smooth or roughen surfaces
- Supplied with adjustable steel nozzle to control output flow rate

NEW PRODUCT

\$247.95



Automotive Fluid Extractor

305167 Pneumatic 6 Litre

- Specifically designed to extract automotive fluids including brake fluid, coolant engine oil, transmission oil and hydraulic oil
- Includes brake caliper bleeding port adaptor with 1 metre clear hose and 1.1m fluid suction hose
- Conical spout for non-spill discharge of waste fluid
- Adjustable flow rate
- Heavy duty polyethylene

\$64.95

Pistol Grease Gun

305221 Heavy Duty 450g

- Pistol grease gun with 100mm steel extension, 300mm flexible hose and 4 jaw coupler
- Suitable for both cartridge and bulk fill
- Cartridge capacity: 450g
- Bulk capacity: 650cm³
- Output: 0.5g per stroke
- Pressure: 34,500 kPa



\$33.95

Fuel Tank Retaining Ring Remover

307001

- Universal three legged fuel tank retaining ring remover suitable for the removal of in-tank fuel pumps and fuel sender units
- Fully adjustable and features a 24mm hex drive
- Working size range of 75-160mm

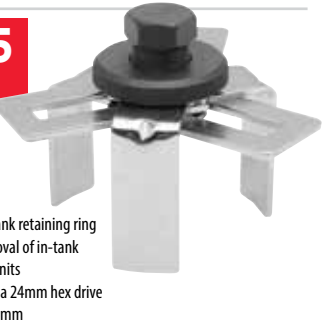

\$210.95

A/C Fuel Line Disconnect Tool Set

307010 Master Set 27 Piece

- Covers all common uses and applications including fuel line couplings, air conditioning line couplings, clutch connectors, transmission cooler line connectors and air supply lines



TOOL SALE

FAMOUS TOLEDO
EXCELLENCE BY DESIGN

TOLEDO SPECIALS · TOLEDO TOOL SPECIALS · TOLEDO TOOL SPECIALS

\$770.95

Diesel Injector Tester

307350 Mechanical 0-8700PSI (0-600BAR)

- Enables testing of diesel injectors by checking leakage, spray patterns, atomisation and cracking/opening pressure
- Transparent spray guard enclosure circulates fluid back
- Manufactured from high grade aluminium and steel
- Includes three adaptors
- Manometer (Dual Scale): 0-8700psi/0-600bar



\$76.95

Cooling System Flushing Gun

308239

- Provides high pressure cleaning of radiators and heater cores
- Simply connect air line and water supply and pull trigger
- Stepped cone sizes Ø 19, 29, 32, 37, 40mm



\$618.95



Cooling System Pressure Tester & Vacuum Purge Kit

308500 Master 36 Piece

- Comprehensive master kit for cooling system pressure testing, radiator cap pressure testing and cooling system purge and refill
- Full vehicle application list included for AUS CARPARC



NEW Adaptors & Contents

No.16 Adaptor

No.18 Adaptor

No.23 Adaptor

No.21 Adaptor

No.22 Adaptor

90° Elbow Connector

No.24 Exclusive Brand New Hyundai Adaptor

NEW PRODUCT

\$40.95

Tyre Tread Depth Gauge

309103 Digital

- Measure centreline and shoulders of tyre tread depth for passenger vehicles, light commercial and motorcycle tyres
- Automatic off function when left unused to conserve battery life
- Measuring range: 0 to 25mm/0 to 1in
- Accuracy: ≤0.05mm/0.002in



\$19.95

Wheel Weight Plier

309243 Standard Wheels

- For fitting wheel weights on to steel rims when balancing wheels
- Suitable for removing, cutting and installing clip-on wheel weights
- Drop forged, heat treated steel with PVC dipped handles
- Suits standard steel rims



\$14.95

Tyre Valve Remove Set

309246 2 Piece

- Used for the removal and installation of tyre valve cores
- Moulded plastic handles allow for a secure grip
- Regular reach unit for passenger vehicles and motorcycles – 110mm long
- Long reach unit ideal for trucks – 155mm long

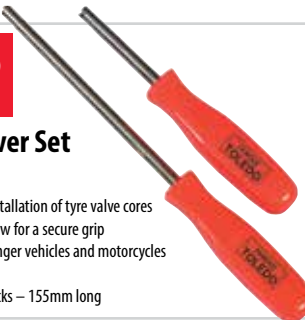

NEW PRODUCT

\$257.95

Brake Pressure Bleed Kit

309980 3 Litre

- Professional one person operation brake bleeding kit
- Efficient way to bleed brake system after repairs and flush out old brake fluid during service through the master cylinder
- Safe to use on most brake systems equipped with ABS
- Includes 90° swivel adaptor suitable for most European style brake fluid reservoirs (M46.5 x 3.5mm)
- Includes brake fluid bleeder bottle fitted with rubber bleeding port adaptor, hook and transparent hose
- Bleed bottle capacity: 1 Litre
- Pressure (Max): 60PSI



NEW PRODUCT

\$398.95

Brake Bleeder Adaptor Set

309981 6 Piece

- Specifically designed for use with Brake Bleed Pressure Kit (309980)
- Flush brake fluid by pressuring master cylinder
- Suitable for popular make and model brake master cylinders including Toyota, Ford, Hyundai, Honda etc.



NEW PRODUCT

\$133.95

Brake Bleeder Adaptor Adjustable

309982 Universal

- Specifically designed for use with Brake Bleed Pressure Kit (309980)
- Tapered rubber adaptor with swivel fitting
- Adjustable clamping arms and depth adjustments
- Safe to use on brake system equipped with ABS
- Quick connect coupler prevents back flushing and avoid spills when disconnecting
- Clamping range: 116-168mm
- Depth: 86.5-103mm



\$234.95

CV Boot Installation Tool

311018

- Designed to stretch the CV boot over the CV joint without the need to dismantle the CV shaft
- Not suitable for plastic type CV boots



\$527.95

Hydraulic Flaring Tool Kit

310006 with 8T Ram

- Comprehensive all in one set of kit includes hydraulic flaring tool with dies and punches, debur tool, tube bender and cutter
- Suits: Copper, Brass, Aluminium and Mild Steel pipe
- Pipe Sizing: 3/16", 4.75mm, 5mm, 6mm, 1/4"
- Produces: DIN and SAE single and double flares



\$757.95

Universal Press Support Tool

311021

- For safe and easy shop press work
- Press plate 200 x 240 x 40mm, swivel plate and adjustable anvil bolts
- Made in Germany



\$1866.95

Universal Bearing & Bush Hydraulic Press Frame Kit

311022 Flexible Head 180°

- For the removal and installation of bearings, bushes and ball joints
- The unique press frame design allows for complete portability
- Contains 22 press sleeves that are suitable for most passenger, 4WD and light commercial vehicles
- The 10T hydraulic ram is strong enough to remove the most stubborn bushes or ball joints
- Supplied in a heavy duty blow mould case with castor wheels
- Inside diameter range: 18-60mm
- Outside diameter range: 26-68mm



**FAMOUS
TOLEDO**
EXCELLENCE BY DESIGN



TOLEDO TOOL SPECIALS - TOLEDO TOOL SPECIALS - TOLEDO TOOLS



\$146.95

Inner Tie Rod Tool Set 311287

- Specialty kit designed for inner tie rods which are inaccessible to adjust
- Sizes include: 14, 17, 33.6 (mm) and 1 3/16", 1 1/4", 1 5/16", 1 7/16"



\$60.95

Inner Tie Rod Tool Multi-Purpose 311290

- Replaces inner tie rods without the need to remove the steering rack
- Ideal tool for all steering service and repair work
- Unique design prevents damage to steering components
- Operating capacity: 33-42mm



\$797.95

Body Repair Kit 313029 Hydraulic 10 Tonne

- Heavy duty professional kit features 15 different quick connect hydraulic attachments for body and frame work
- Supplied with 10 tonne hydraulic ram and extension tubes
- Comprehensive multi-purpose kit makes light work of straightening, bending, pressing or spreading steel
- Supplied in heavy duty blow mould case with castor wheels for easy portability



\$25.95

Trim & Clip Remover Set 313030 2 Piece

- Damage free removal of trim and clips
- Fully hardened specialty steel with ergonomic acetate handle
- 5 - 7mm and 6 - 9mm

NEW PRODUCT



\$43.95

High Leverage Trim Tool Set 313320 2 Piece

- Designed for levering where extra lift is required
- Rubber pivot provides high leverage without damaging surface
- Includes wedge and round ends
- Applicable for automotive and industrial applications
- Minimise scuffing on delicate surfaces
- Overall: 226mm and 250mm

NEW PRODUCT



\$35.95

Panel Wedge Trim Removal Set 313321

- Durable non-marring panel wedge set
- Suitable for removing interior and exterior trims, moulds and badges etc.
- Wedge ends suitable for striking with a mallet when extra force is required
- Includes one version with ergonomic non slip handle
- Blade width: 72mm (3")



\$21.95

Precision Oblique Cutters 321006 135mm

- Cutting edges for cutting and twisting soft wire
- Used in fine electrical and electronics applications
- Light weight tool with low friction spring return
- Jaw opening (max): 15mm
- Cutting Capacity: Medium hard wire up to 1.2mm



\$49.95 FROM

D-Sub Deutsch 4 Way Indent Crimpers

- Crimps round barrel contacts, pins or sockets
- Built in locator ensures accurate positioning of the pin and socket prior to crimping
- Adjustable pin height locator

Part No.	Size		PRICE
	AWG	mm ²	
321024	26 - 20	0.14 - 0.5	\$49.95
321025	20 - 12	0.5 - 4.0	\$53.95
321093	16 - 18	1.5 - 1.0	\$57.95
321094	20 - 22	0.5 - 0.3	\$57.95

ONLY WHILE STOCKS LAST!



Ball Pein Hammers

- Perfect hammers for a multitude of striking applications
- Durable alloy steel head

Part No.	Handle	Weight	PRICE
321051	Carbon Fibre Handle	16oz	\$28.95
321052	Carbon Fibre Handle	24oz	\$37.95
321053	Carbon Fibre Handle	32oz	\$42.95
321054	Hickory Handle	16oz	\$25.95



\$32.95

Curved Claw Hammer 321055 20oz

- The unique ergonomically design handle prevents the hammer from slipping out of the users hand while striking



\$45.95

Club Hammer 321056 3lb

- Made from carbon steel with a fibreglass and rubber handle



\$107.95

Sledge Hammer 321057 10lb 910mm

- Durable hardened carbon steel head, ideal for repeated high impact applications



\$14.95 FROM

Rubber Mallets

- Black natural rubber head provides enough force without damaging the striking surface

Part No.	Handle	Weight	PRICE
321090	Wooden Handle	16oz	\$14.95
321091	Wooden Handle	24oz	\$16.95



\$5.95

Wire Brush Wooden Handle 321077 235mm

- Suitable for removing rust, corrosion, scale and ingrained dirt
- Bristles are hardened and tempered for strength and durability
- Oil resistant ergonomic wooden handle prevents slippage when in use

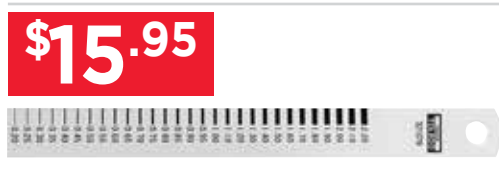

\$15.95

Rule & Crack Measure 321079 150mm

- Gauge: 0.10 - 2.20mm
- Check the width of cracks in walls and foundations
- Hardened Japanese stainless steel
- Made in Japan

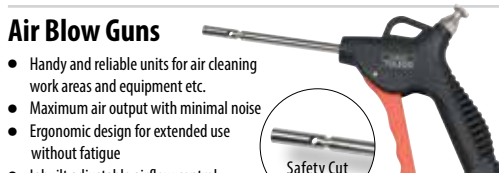

Air Blow Guns

- Handy and reliable units for air cleaning work areas and equipment etc.
- Maximum air output with minimal noise
- Ergonomic design for extended use without fatigue
- Inbuilt adjustable airflow control

Part No.	Nozzle Length	Nozzle Width	Inlet	PRICE
321100	100mm	8mm	1/4" NPT	\$18.95
321101	355mm	8mm	1/4" NPT	\$23.95
321102	60mm	8mm	1/4" NPT	\$18.95
321103	120mm with Rubber Tip	6-16mm	1/4" NPT	\$18.95

NEW PRODUCT



\$58.95

Socket Reducer Set 321109 Impact Heavy Duty

- Designed to reduce or increase socket drive
- Enables greater flexibility when working in limited spaces
- Size: 1/4", 1/2", 3/8", 1/2"

NEW PRODUCT

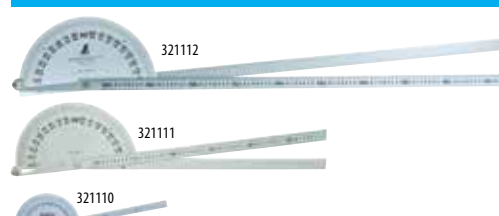

Protractors Double Blade 180°

- Professional stainless steel double blade etched with bold, easy to read graduations
- Essential measuring tool for industrial, automotive, manufacturing, engineering and aerospace work
- Features convenient centre lock nut to secure measurement
- Double blade maintains stability and firmly contours shape at any angle
- Made in Japan

Part No.	Size	Thickness	Angle Pitch	Length	PRICE
321110	210mm	2.0mm	0.5°	385mm	\$398.95
321111	320mm	2.0mm	0.5°	650mm	\$681.95
321112	320mm	2.0mm	0.5°	1050mm	\$832.95



\$49.95

Soft Face Hammer 321303 35mm

- Ideal for fine bodywork adjustment or striking finely finished surfaces without causing damage

NEW PRODUCT



\$81.95

Digital Thermometer 321501 Pen Style 200mm

- Measures air, liquid and surface temperature via the stainless steel probe
- Features hold MIN/MAX and AUTO OFF functions
- -50 to +300°C (-58 to +572°F)



Stainless Steel Flexible Metric Rules

- Toledo flexible rules are thinner in width and thickness to allow for damage free bending
- Accurate to Japanese Industrial Standard 7516 - grade one specifications
- Certified by both JIS (Japan Industrial Standards) and JCS (Japan Calibration Service System)

Part No.	Length	Width	Thickness	Graduations	PRICE
321900	300mm	15mm	0.5mm	Upper: 1mm Lower: 0.5mm	\$26.95
321901	600mm	15mm	0.5mm	Upper: 1mm Lower: 0.5mm	\$63.95

TOOL SALE

FAMOUS TOLEDO
EXCELLENCE BY DESIGN

TOLEDO TOOL SPECIALS · TOLEDO TOOL SPECIALS · TOLEDO TOOL SPECIALS

\$33.95

Fibreglass Folding Rule

321902

Double Sided Metric 2000mm

- Divided into 220mm sections connected via a reliable and sturdy fix joint mechanism which enables extensions of 90° or 180° to firmly lock into place
- Double sided metric graduations
- Manufactured from durable fibreglass
- Made in Switzerland

NEW PRODUCT

\$75.95

Hose Clamp Pliers

321909 Multi-Directional 35°

- Jaws with serrated and cross slots suitable for various spring type hose clamps
- Multi-directional pliers give wide range of angles in confined spaces
- Serrated jaws give a secure grip onto spring loaded hose clamps
- Overall length: 255mm

\$88.95

Right Angle Drill Attachment

321921

- Suitable for use with cordless or corded drills
- 90° head allows to access confined space
- Provides up to 49Nm of torque
- Includes PH1 and PH2 bits
- Made in Japan

\$26.95

Tape Measure

321910 10m Metric Double Sided Auto Lock

- Strong and robust design with ABS and TPE shock-proof casing
- Double sided metric graduations
- Automatic blade lock function provides easy set-up allowing one person operation
- Ergonomic design with belt clip and hanging tether

\$4.95

Tape Measure

321922 2m Metric Single sided Pocket Size

- Ergonomic design with handy keychain ring

\$42.95

Measuring Tape Steel

322018 30m Single Sided Metric

- Heavy duty design with ABS and TPE shock-proof casing
- Single sided metric graduations

PRICE DROP!



Tamperproof TORX Screwdrivers

- Designed with user comfort in mind, grips the hand firmly and comfortably
- Suitable for heavy duty professional use
- Made in Japan

Part No.	Size	Length mm	PRICE
321911	T9 X 100mm	166	\$11.95
321912	T10 X 125mm	213	\$13.95
321913	T15 X 125mm	320z	\$15.95
321914	T20 X 125mm	213	\$16.95
321915	T25 X 125mm	213	\$18.95
321916	T27 X 125mm	234	\$20.95
321917	T30 X 125mm	234	\$21.95
321918	T40 X 125mm	249	\$23.95

PRICE DROP!



Ergo-Line Screwdrivers

- Ergonomic dual piece handle
- Inner plastic core permanently locks with blade
- Comfortable rubber handle is moulded to fit the hand
- Non-roll handles to prevent tool loss and minimise downtime
- Made in Japan

Part No.	Type	Blade Length	Overall Length	PRICE
321940	Phillips #1	75mm	175mm	\$13.95
321941	Phillips #2	100mm	230mm	\$15.95
321942	Phillips #2	150mm	280mm	\$16.95
321943	Phillips #2	200mm	330mm	\$17.95
321944	Phillips #3	150mm	280mm	\$18.95
321945	Slotted 5.5mm	75mm	175mm	\$13.95
321946	Slotted 6mm	100mm	230mm	\$15.95
321947	Slotted 6mm	150mm	230mm	\$16.95
321948	Slotted 6mm	200mm	330mm	\$17.95
321949	Slotted 8mm	150mm	280mm	\$18.95

PRICE DROP!

Stub-Line Screwdrivers

- For hard to reach applications where access is limited
- Wide mini handles for extra comfort and grip
- Ergonomic dual piece handle
- Dimpled to provide additional finger grip and prevent rolling
- Maximum strength, grip and torque
- Made in Japan

Part No.	Type	Blade Length	Overall Length	PRICE
321971	Phillips #2	30mm	76mm	\$11.95
321972	Slotted 6mm	30mm	76mm	\$11.95

PRICE DROP!



Strike-Line Screwdrivers

- High-grip bulb handles
- Unique design enables greater grip and torque
- Dual piece handles for strength and comfort
- Non-roll handles to prevent tool loss and minimise downtime
- Shatterproof impact steel cap with strike-thru blade
- Made in Japan

Part No.	Type	Blade Length	Overall Length	PRICE
321950	Slotted 5.5mm	75mm	155mm	\$13.95
321951	Slotted 6mm	100mm	200mm	\$18.95
321952	Slotted 6mm	150mm	240mm	\$20.95
321954	Phillips #2	100mm	200mm	\$18.95
321955	Phillips #2	150mm	240mm	\$20.95

PRICE DROP!



Elec-Line Screwdrivers

- Tested up to 1000V with special insulating attributes
- High-grip bulb handles
- Unique design enables greater grip and torque
- Dual piece handles for strength and comfort
- Non-roll handles to prevent tool loss and minimise downtime
- Made in Japan

Part No.	Type	Blade Length	Overall Length	PRICE
321960	Phillips #2	100mm	200mm	\$15.95
321961	Slotted 5mm	100mm	200mm	\$15.95

PRICE DROP!

\$28.95

Elec-Line Box Set

321990 2 Piece

- Includes PH2 x 100mm and Slotted 5 x 100mm
- Insulated screwdriver solution for live electrical work
- Tested up to 1000V for professionals working with dangerous live electrical applications
- Made in Japan

\$138.95

Tamperproof TORX Screwdriver Set

321987 8 Piece

- Set contains eight tamperproof Torx screwdrivers ranging from T9 – T40
- Features a custom moulded foam inlay with identification markings and precision cut outs for firm tool retention
- Made in Japan

\$96.95

Ergo-Line Screwdriver Set

321983 7 Piece

- Phillips and slotted standard - Slotted 5.5, 6 and 8mm, Phillips #1, #2 and #3
- Gearless stubby with clip on bit set
- Made in Japan

\$69.95

Strike-Thru Screwdriver Set

321985 5 Piece

- Contains Slotted 5.5 x 75mm, 6 x 100mm, 6 x 150mm and PH2 x 100mm and PH2 x 150mm
- Shatterproof impact steel cap with strike-thru
- Made in Japan

\$34.95

Magnetic Torpedo Level

322010 250mm

- Handy magnetic level suitable for minor and major tasks
- Features horizontal and vertical shockproof acrylic vials
- Precision milled flat surface with an accuracy of <0.5mm/m (0.0005 in/in)

\$26.95

Pipe Level Set

322011 5 Piece

- Sizes: 1/2", 3/4", 1", 1 1/4", 1 1/2" and 2"

\$18.95

Exacta Post Level

322012 Magnetic

- Folds closed and opens flat with a click-lock every 150°
- Inbuilt adjustable elastic strap for all non-magnetic surfaces
- Length: 190mm
- Width: 19mm
- Thickness: 3mm

\$14.95

Mini Magnetic Level

322013 100mm

- Small - lightweight and durable magnetic level perfect for a wide range of applications
- Shockproof solid acrylic vial provides a quick and accurate reading
- Lightweight aluminium box profile fits easily into any tool belt or pocket
- Accuracy: 0.05 mm/m



MAGNA

FAMOUS TOLEDO
EXCELLENCE BY DESIGN

TOLEDO TOOL SPECIALS · TOLEDO TOOL SPECIALS · TOLEDO TOOL

\$9.95

Mini Magnetic Cross Level

322014

- Handy pocket size magnetic cross level
- Suitable for horizontal and vertical applications
- Pre-cast hoses for permanent fixation



\$18.95

Rafter Square

322015 Ergocast Plastic 7"

- Ideal for marking and cutting of rafters, stairs or any basic angle
- Tri-square, miter square, protractor, line scribe and saw guide all in one
- Moulded-in conversion tables that never fade or rub off
- Marked with degree graduations for fast, easy layout



\$18.95

T-Bevel 322016

180mm with level

- Heavy duty design for various industrial applications
- Double sided, etched stainless steel blade with metric and imperial graduations
- Easy to read vial in handle



\$234.95

Digital Laser Distance Measurer 322053

70m

- Professional distance measurer for simple, quick and precise distance reading with the push of a button
- Calculates volume/area, tracking and indirect height



\$45.95

Multi-Scan Digital Stud Finder 322054

- Easy to read back lit LCD screen marks exact position
- Powerful inbuilt electronic sensors detect live AC wires, metal, studs and wood located behind gyprock and other common wall materials

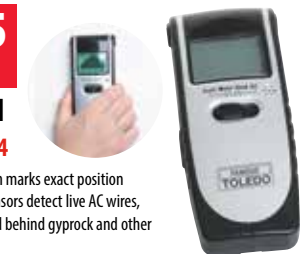

\$149.95

Vernier Caliper 322200

Metric & Imperial Digital 150mm/6"

- Professional digital vernier caliper provides metric and imperial read outs
- Range: 0-150mm (0-6")



\$92.95

Vernier Caliper 322201

Metric & Imperial Analogue 150mm/6"

- For inside and outside measurements in both metric and imperial
- Hardened stainless steel with satin chrome finish



Magnetic Digital Box Levels

- Digital magnetic box level with degree, percentage and pitch modes
- Tilted backlit LCD screen swivels for upright read out
- Hold function with up to 9 memory store and recall space
- Audible buzzer at buzzer at 0°, 45°, 90°

Part No.	Length	Resolution	PRICE
322050	600mm	0.05°	\$159.95
322051	1200mm	0.05°	\$212.95



Magnetic Box Levels

- Reinforced aluminium frame
- Epoxy locked shockproof vials
- Precision milled surfaces for accuracy (up to 1200mm)
- Enlarged easy read horizontal vial (33% bigger)
- Unique side-view vial provides accurate plumb reading
- Powerful rare earth magnets
- High accuracy of 0.5mm/m

Part No.	Length	Accuracy	PRICE
322060	600mm	0.5mm/m	\$87.95
322090	900mm	0.5mm/m	\$96.95
322120	1200mm	0.5mm/m	\$101.95
322180	1800mm	0.5mm/m	\$140.95
322240	2400mm	0.5mm/m	\$158.95



\$309.95

Measuring Wheel 322552

Digital 10km

- Large backlit LCD displays metric and imperial measurements
- Wheel design allows manoeuvring through rough surfaces
- Supplied in heavy duty nylon bag
- User guide included



\$17.95

Adjustable Combination Square CS30012

Metric & Imperial 300mm/12"

- For use as inner or outside try square, mitre square, horizontal, 45° and plumb level, depth and marking gauge and rule
- Detachable ruled blade
- Spirit level for checking level and plumb



\$22.95 FROM

Combination Fencing Pliers

- Includes three specially designed wire cutters
- Serrated gripping zones for flat and round material

Part No.	Jaw Opening	Jaw Width	Length	PRICE
FP10	0-52mm	13mm	260mm	\$22.95
FP12	0-60mm	14mm	300mm	\$32.95



\$16.95

Electro-Mechanical Cutters PC6

- Hardened precision cutting edges for cutting and twisting soft wire
- Suitable for use in fine electrical and electronics applications
- Ideal for cutting plastic e.g. cable ties
- Jaw length: 20mm
- Jaw opening: 0-20mm
- Cut type: Flush

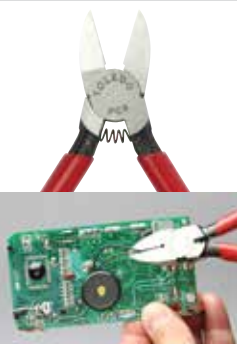

\$20.95 EACH

Key Sets Ball Point Hex 7 Piece

- Double ended tools featuring one standard hex end and one ball hex end
- Improved access to application and up to 25° working angle for increased speed and ease of entry

Part No.	Contents	Type
HKM	2.5, 3, 4, 5, 6, 8, 10mm	Metric
HKAF	3/32", 1/8", 5/32", 3/16", 1/4", 5/16", 3/8"	Imperial



Mitre Squares Stainless Steel

- Suitable for use as inner or outside try square, mitre square, horizontal, 45° marking gauge and rule
- Graduated blade with metric and imperial markings
- Made in Japan

\$33.95 FROM

Part No.	Length	Graduations	PRICE
MS150	150mm	Upper Edge: 1mm Lower Edge: 16/1"	\$33.95
MS200	200mm	Upper Edge: 1mm Lower Edge: 16/1"	\$34.95
MS250	250mm	Upper Edge: 1mm Lower Edge: 16/1"	\$36.95
MS300	300mm	Upper Edge: 1mm Lower Edge: 16/1"	\$39.95



Thickness Gauge Metric

Lever Type 322108 Deep

- High precision expert thickness gauge for precision measuring work
- Ideal for measuring the thickness of small parts, metal, glass, plastic, rubber, vinyl, foil and other sheet material
- Made in Japan

\$45.95

Ratcheting Crimping Pliers 302021

Standard 220mm

- For fast, efficient and easy crimp work



\$61.95

Auto File Set TFR250B 4 Piece

- Specially created file set to cater for automotive use
- Includes 2nd cut round, half round, square and bastard cut flat



\$101.95

Circlip Plier Tool Roll TCPR01

4 Piece

- Four piece set includes external and internal straight circlip pliers
- Supplied in heavy duty tool roll
- External Straight Tip 130mm (5")
- External Straight Tip 230mm (9")
- Internal Straight Tip 130mm (5")
- Internal Straight Tip 230mm (9")



\$128.95

Plier & Cutter Set TPSA01

4 Piece

- Professional trade quality plier set includes combination, diagonal cutter, long nose and multi-grip pliers
- Chrome molybdenum with black phosphate finish
- High grade EVA foam tray



\$92.95

Long Nose Plier Set TPSA03

Extra Long 3 Piece

- Premium trade quality set features three different tip styles including straight, 45° bent and 90° bent
- Chrome molybdenum with PVC dipped handles
- High grade EVA foam tray
- Overall lengths: 280mm



\$24.95

Precision Rule Set TRS01

Extra Long 3 Piece

- Contains 150mm and 300mm rules
- Double sided metric and imperial with upper and lower graduations
- Made in Japan



TOOL SALE

FAMOUS TOLEDO
EXCELLENCE BY DESIGN

SPECIALS • TOLEDO TOOL SPECIALS • TOLEDO TOOL SPECIALS

\$38.95 EACH

Oil Filter Wrench

- For removing stubborn and difficult to reach oil filters
- Designed for high torque requirements
- Suitable for removing oil filters, fuel filter/water separators



Part No.	Sq.Dr mm	Band Width mm	Size mm
305081	1/2	40	105-120
305082	1/2	40	115-135
305083	1/2	40	125-145

\$290.95



Turbo Boost Leak Pressure Tester

- 304999** 9 Piece
- For diagnosing fine boost leaks in forced induction engines
 - Professional kit pressurise the turbo charging system without having the engine running
 - Suitable for testing turbo plumbing, intercooler, turbo housing and blow off valve etc
 - Size range: Ø35 - 90mm
 - Working pressure: 25psi

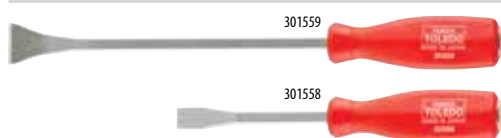

Strike Thru Scrapers Extra Heavy Duty

- For scraping baked on gaskets, seals, cured silicone etc
- Extra strong steel striking cap provides endless blow without mushrooming end
- Ergonomic design handle provides non slip grip
- Made in Japan

Part No.	Description	Tip Width	Shaft	Length	PRICE
301558	Straight Blade	15mm	110mm	235mm	\$33.95
301559	Curved Blade	30mm	230mm	355mm	\$40.95



\$33.95

Fuel Filter Wrench

- 307000**
Diesel Hyundai/KIA
- Essential tool for removing diesel fuel filters on Hyundai and KIA models
 - Applicable for Hyundai/KIA 2.0-2.2L CDDi engines
 - Thin design allows enable to use in confined spaces
 - 1/2" Square drive suitable for removing stubborn fuel filters



\$239.95

Ball Joint C Frame Press Kit

311019 10 Piece

- For the removal and installation of ball joints including brake anchor pins and tail shaft U joints
- Universal tool applicable for AWD, FWD & RWD passenger and light commercial vehicles
- Includes various sleeves and adaptors for pressing or to draw bushes
- Max load: 4 tonnes



\$109.95

Exhaust Gas Temperature Sensor Socket Set

301561 3/8" Sq. Dr

- Size: 13, 14, 17mm 6 Piece
- Specific socket set for removing exhaust gas temperature sensors (EGT)
 - Includes single hex sockets in offset shallow and straight deep configuration
 - Features cut away design allowing the wire to pass through without damaging plug
 - Suitable for passenger, heavy goods vehicles, tractors and marine diesel engines



\$84.95

Crowfoot Wrench Set

302999

1/4" Metric Straight

9 Piece

- For use in confined work areas where standard wrenches are unable to access
- Straight jaws suitable for low torque applications
- Includes breaker bar and extension



\$52.95

Slot Chisel Heavy Duty

301560 Straight 240mm

- For the removal of slag during steel cutting or welding
- For cutting thin sheet metal, removing corroded bolt heads, removing old paint and rust removal
- Unique thin design maintains sharpness of blade
- Heavy duty specially hardened and tempered alloy steel
- Blade thickness: 5.5mm
- Blade width: 25mm
- Made in Japan



Dual Cutting Chisel End

\$109.95

Screw Extractor Set

301535 Heavy Duty 9 Piece

- For removing broken, stripped and corroded fasteners
- Utilises left hand spiral design for gripping and removal
- Includes metric and imperial size range with recommended drilling size
- Size range: 1/8" - 1 1/4" (3 - 36mm)



NEW PRODUCT

\$147.95

Face Spanner Wrench Set

315158 Adjustable 9 Piece

- Suitable for loosening and tightening nuts
- with holes on surface
- Knurled central divider type nut allows
- with adjustment and locks it into place
- Changeable pins suit various size holes
- Capacity: 20-100mm
- Pin size: 2.5, 3, 4, 5, 6, 7, 8 and 9mm



\$202.95

Fuse Saver Digital

302199

- Designed for the protection of on board computers and modules from current overloading during diagnosing
- Suits standard and mini blade fuse types
- Capacity: 2A, 3A, 4A, 5A, 10A, 15A, 20A, 25A, 30A



\$76.95

Wheel Hub Cleaner

321078 Dia: 150mm 1/2" Sq. Drive

- Cleans the surface of the wheel hub
- Removes corrosion and debris to ensure flush fitment of wheel surface



\$105.95

Wheel Hub & Stud Cleaner Kit

321204 8 Piece

- For cleaning corrosion on wheel hub surfaces and wheel studs
- Includes drill attachment and spare pads
- Brush size: 13mm & 18mm
- Grinding pad: Ø23mm x 3 & Ø15mm x 2



\$597.95

Capacity: 35-105mm
Spread: 170mm
Reach: 900mm

Bearing Separator Kit 265015

Mechanical & Hydraulic 3 Jaw

- Kit contains all the components for mechanical and hydraulic assembly
- Removes stubborn bearings, gears, sprockets and pulleys effortlessly without damaging shaft and surrounding components
- Includes heavy duty 10 tonne hydraulic ram and 210mm forcing screw with centre nut, triple beam, various extension rods, puller leg set and three jaw bearing separator



\$464.95

Brake Fluid Tester 310009 Digital

- Measures the boiling point of the brake fluid
- LCD display provides brake fluid condition
- Includes syringe and testing beaker
- Suitable for all dot brake fluids



\$261.95

Brake Disc Removal Kit

310260 170-400mm

- Removes stubborn brake discs
- Reduce impact on wheel bearings, ball joints, suspension and electrical sensors
- Suitable for passenger and light commercial vehicles
- Capacity: 170 - 400mm



\$337.95

Fluid Extractor 305164

10 Litre Manual & Pneumatic

- For extracting fluids easily and efficiently
- Handy for the extraction of engine oil via the dipstick
- Suitable for engine oil, transmission fluid, differential, brake fluid and hydraulic oils etc.
- Includes 4 various suction tube sizes
- Manufactured from durable polypropylene





MADE IN GERMANY



KNIPEX TOOL SPECIALS · KNIPEX TOOL SPECIALS · KNIPEX TOOL SPECIALS

\$137.90

**KNIPEX Cobra® Set
00 31 20 V01**

- Set containing two popular Cobra® pliers
- Push button for adjustment
- Self-locking on pipes and nuts

Description	Length mm
KNIPEX Cobra® HighTech Water Pump Pliers	180
KNIPEX Cobra® HighTech Water Pump Pliers	250



\$107.30

**KNIPEX Alligator® Set
00 31 20 V02**

- Set containing two popular Alligator® pliers
- Box joint design
- Self-locking on pipes and nuts
- Ideal for outdoor work - insensitive to dirt

Description	Length mm
KNIPEX Alligator® HighTech Water Pump Pliers	180
KNIPEX Alligator® HighTech Water Pump Pliers	250



\$199.00

**KNIPEX Cobra® & Plier
Wrench Set 00 31 20 V03**

- Set containing two popular pliers
- Includes Cobra® - gripping surfaces with special hardened teeth and Plier wrench - smooth jaws, pliers and wrench in a single tool

Description	Length mm
KNIPEX Cobra® HighTech Water Pump Pliers	250
Plier Wrench	180



\$79.50

**Multiple Slip Joint Spanner 'Raptor'
87 41 250 250mm**

- For metric and imperial nuts and screws with width across flats from 10 and 32mm (3/8 up to 1 1/4") self locking from 17mm: no slipping on the workplace
- Zero backlash gripping of metric or imperial hexagonal headed screws, no rounding of bolt heads
- **Reliable and tight gripping of rounded, rusty or thick coated bolts and screws**
- Ideal for work on vehicle brake systems
- Push the button for adjustment on the workpiece, also possible with one hand only



NEW PRODUCT

\$68.70

**KNIPEX BIX Plastic
Pipe Cutters
90 22 10 BK**

- Cuts pipes quickly, cleanly and without shavings
- Can be used to cut sealing sleeves during final assembly
- Locking mechanism for safe transport
- Two spare blades integrated in the tool



NEW PRODUCT

\$186.00

**Electrician's Pliers
Wire Stripper 13 7 28 American Style 200mm**

- Cuts 6-32 and 8-32 screws without threading and can be cut from either the front or the back
- Strips 10 to 20 AWG - both solid and stranded
- Locating ridges make it easy to find stripping holes
- Wire looping groove to loop wire for attaching to screws
- Conduit reaming for removing burrs

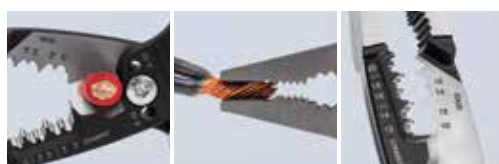

\$114.00

**Wire Rope Cutters
95 62 190 Forged 190mm**

- With two crimping dies for end caps on Bowden cable sheaths and end ferrules for traction cables
- Comfortable work thanks to handy, slim design and internal opening spring



\$137.00

Cable Shears 95 06 230 Single Cutting Edge 230mm

- For cutting copper and aluminium cables
- Not suitable for steel wire and hard drawn copper conductors
- Easy cutting with one-hand operation due to high transmission ratio



Cable & Dismantling Knives 1000 V

- Ergonomically improved handle shape with comfortable slip guard
- Particularly confident grip thanks to slip-proof soft components
- Thumb recess and **finger hook** at the end of the handle ensure a good transmission of force when the blade is pulled
- Transparent protective cap
- VDE tested according to DIN EN/IEC 60900 : 2004

Part No.	Handles	Blade	Length mm	PRICE
98 54	Cable Stripping	Straight	180	\$34.85
98 55 155	Dismantling	Hook Sickle	155	\$96.00
98 53 13	Dismantling	Narrow Sickle	180	\$35.75

\$170.00

**Cirdclip Plier Set
00 20 03 V02 4 Piece**

- Contains common cirdclip pliers for internal and external circlips

Name	Size of Bore	Style	Qty
Internal	12-25 Ømm	Straight	1
Internal	19-60 Ømm	Straight	1
External	10-25 Ømm	Straight	1
External	19-60 Ømm	Straight	1



NEW PRODUCT

\$249.00

**Mini Pliers Set
00 20 72 V06 Belt tool pouch 2 Pieces**

- For gripping, holding and cutting tasks, both large and small
- **KNIPEX Mini Cobra®** 87 01 150 adjustment directly on the workpiece at the press of a button
- **Needle nose combination pliers** 08 22 145: ideal for working in hard-to-reach places thanks to the slender head shape
- Soft, medium hard and hard wire up to Ø 2mm



Electronic Super Knips® XL 140mm

- Precision pliers for ultra fine cutting work
- Suitable for flush cutting of cable ties

Part No.	Handle	Finish	Length mm	PRICE
78 03 140	Comfort Grip	Polished	140	\$69.75
78 61 140	Comfort Grip	Black Atramentized	140	\$72.40



High Leverage Diagonal Cutters

- High cutting performance with minimum effort
- For very tough, continuous use
- Precision cutting edges additionally hardened

Part No.	Handles	Length mm	Capacity mm			PRICE
			Medium	Hard	Piano	
74 02 180	Comfort	180	3.8	2.7	2.2	\$78.95
74 02 200	Comfort	200	4.2	3.0	2.5	\$84.00
74 02 250	Comfort	250	4.6	3.5	3.0	\$95.00



KNIPEX Cobolt® Compact Bolt Cutters

- Precision cutting edges for soft and hard wire as well as piano wire
- *71 12 200 with opening spring and locking device
- Cuts bolts, nails, rivets, etc. up to 5.2 mm dia
- Improved cutting performance

Part No.	Handles	Length mm	Capacity mm				PRICE
			Soft	Medium	Hard	Piano	
71 01 200	Plastic	200	6.0	5.2	4.0	3.6	\$99.95
*71 12 200	Comfort	200	6.0	5.2	4.0	3.6	\$115.00

\$265.00

**Combination Plier Set
00 20 01 V08 4 Piece**

- Set of top four selling Knipex pliers stored in an EVA foam tray
- Pliers arranged clearly and well protected
- For common tool trolleys and workbenches

Description	Handles	Length mm
Combination Pliers	Comfort	200
Long Nose Pliers	Comfort	200
High Leverage Diagonal	Comfort	200
Cobra Pliers	Plastic	250



Carpenters' Pincers

- For heaviest duty
- Specially favoured by craftsmen for their precise workmanship
- Extreme wear resistance and well balanced
- Cutting edges additionally hardened - cutting edge hardness approx. 60 HRC

Part No.	Handle	Finish	Length mm	PRICE
50 00 300		Black Atramentized	300	\$79.50
50 01 250	Plastic	Black Atramentized	250	\$59.00

TOOL SALE

PROFESSIONAL TOOLS
HIT
MADE IN JAPAN

HIT TOOL SPECIALS · HIT TOOL SPECIALS · HIT TOOL SPECIALS · HIT TOOL SPE-

\$40.00



Hand Wire Rope Cutter

HITHWC06 190mm

- Designed for cutting all soft and hard steel cable and wire
- Cuts copper aluminium 6.0mm, wire rope 2.5mm, ACSR 2.4mm
- Compact and lightweight, allows for access into restricted areas



\$349.00



Threaded Rod Cutter

HITTRC10 Single Head

- A must for construction sites where threaded rods are used to secure pipe, conduit, sprinkler systems, ductwork, lighting, ceiling and many other construction applications
- Cuts fast, clean, with precision and eliminates grinding, filing and thread restoring

Style	Length mm	Cutting Capacity mm	
		Diameter	Pitch
Single Head	740	10	1.50

\$109.00 FROM



Reinforced Rubber Hose Cutters Heavy Duty

- Designed for cutting reinforced rubber hose
- Suitable for gas, air and water hoses that have an inbuilt steel core

Part No.	Length mm	Cutting Capacity mm dia.	Weight kg	PRICE
HITHC400	400	9.5-13	1.0	\$109.00
HITHC500	500	9.5-25	1.8	\$164.00



\$110.00



Wire Rope Cutter HITW16

710mm

- Designed for cutting soft and hard cable, wire rope, ACSR cable
- Extra-long handles provide enough leverage to cut through wire rope up to 16mm in diameter
- Shear-cut jaws provide a clean sharp cut with minimal distortion to the cable
- Ergonomic and comfortable rubber grips

\$169.95



Swaging/Crimping Tool

HITCT600/5 600mm

- Designed for swaging / crimping copper or aluminium swages
- Designed to produce a tight, clean compression of copper and aluminium swages
- Capacity: 1.5, 2.5, 3, 4 and 5mm

\$278.00



Steel Strap Cutter HITSS600SL

Sliding Handling Type 600mm

- Drop forged heat treated alloy steel blades
- Shear cut blades provide a clean, smooth and easy cut - excellent for pallets, shipping and metal recycling yards
- Sliding striker handle - no need to use a hammer to bite into the steel strapping
- Increased efficiency, less effort required

\$69.00

Professional Hand Riveter

HITHR001 Spring Loaded

- Strong durable construction ensures precise riveting
- 4 interchangeable nose pieces for 2.4mm, 3.2mm, 4.0mm and 4.8mm rivets



\$36.00 FROM

Cable Cutters

- Shear-cut blades designed for cutting soft non-steel copper and aluminium cable
- Performs a clean sharp cut with minimal distortion to the cable
- Not suitable for cutting ACSR, wire rope, steel or self-supporting strand

Part No.	Copper IV mm ²	Copper WCT mm ²	Length mm	PRICE
HITSC10	22	50	160	\$36.00
HITSC20	30	60	210	\$39.00
HITSC30	38	90	240	\$43.00



\$117.50

Nail Puller

HITNP450 Heavy Duty 450mm

- Ideal for removing nails and staples from wooden power posts, cases and shipping pallets
- Suitable for all construction worksites and home improvement use
- Forged alloy steel jaws, hardened and tempered with sliding hammer handle

Length mm	Capacity mm	Weight kg
450	6.5	1.65



\$74.00 FROM



Professional Bolt Cutters Black Jaw

- Suitable for general purpose use such as concrete reinforcing rods, medium tensile soft nuts and bolts

Part No.	Jaw Type	Length mm	Cutting Capacity mm		PRICE
			Hard Metal		
HITNBC0450	Side Cut	450	6		\$74.00
HITNBC0600	Centre Cut	600	8		\$96.00
HITNBC0750	Centre Cut	750	9		\$120.00

\$209.00 FROM



Concrete Mesh Cutters

Centre Cut

- Cuts extra hard steel concrete mesh
- Small cutting head provides easy access into restricted spaces
- Comfortable rubber handles ensure a firm and safe grip during operation
- Replacement cutting heads also available

Part No.	Length mm	Cutting Capacity		PRICE
		High Tensile 162kg/mm	Soft Metal 49.6kg/mm ²	
HITRCA800	800	8	10	\$209.00
HITRCA1050	1050	8	10	\$259.00

MEGA

SYKES-PICKAVANT SPECIALS · SYKES-PICKAVANT SPECIALS · SYKES-PICKAVANT SPECIALS

\$215.95

Twin & Triple Leg Puller Kit 082705

- For quick and safe removal of gears, races, bearings, pulleys and sprockets
- Makes four different puller combinations
- Spread 0 - 150mm, Reach 80mm
- **Made in England**



\$70.95

Professional Foldable LED Slimlight 300606

Rechargeable

- Handy foldable pocket pen light for quick and easy illumination
- Features three lighting modes: front fold out flood light with normal and eco modes, rear flood light and direct beam top light



\$19.95 FROM

Collapsible Magnetic Parts Trays

- Unique design allows the parts tray to close fully flat for easy storage
- Height adjustable to suit different applications
- Suitable for safely storing small parts, nuts, bolts and screws
- Strong rubber covered magnetic base prevents scratching on sensitive surfaces
- Sticks to any ferrous surface with ease
- Available in three different sizes



Part No	Shape	Size	Depth Range	Magnet Size	PRICE
680001	Round	135mm	10-80mm	1 x 50mm	\$19.95
680002	Round	225mm	10-115mm	1 x 85mm	\$46.95
680003	Oval	200 x 280mm	10-60mm	2 x 80mm	\$59.95



BONUS PACK

\$229.95

1500 Series Hydraulic Ram SBP029

- Bonus Sykes 082519 ram shock handle
- Provides 8 tonnes of force with minimal effort
- Renowned globally for quality and reliability
- Grease filled bore for consistent high performance
- **Made in England**



FREE

Sykes-Pickavant.

SHOCK HANDLE

- Ideal for stubborn or seized bearings



\$39.95

Professional Pocket LED Pen Light 300600

Rechargeable 170mm

- Bright and robust pocket pen light for quick and easy illumination of dark work areas
- Lighting modes: bottom light with direct beam and work light with wide flood beam
- Inbuilt belt clip with magnet
- High impact ABS plastic housing with impact resistant lens



\$43.95

Professional SlimlineLED Headlight 300607

Rechargeable

- Lightweight and easy to use LED headlamp easily lights up dark areas while keeping your hands free
- Features three lighting modes: eco, normal and sense mode
- Sense mode allows for a truly hands free operation by just swiping your hand in front on the motion sensor to either quickly turn on or off the headlamp



\$87.95

Professional Twinbeam Pocket Worklight 300608

Rechargeable

- Multifunctional Twinbeam worklight contains both a spot light and flood light
- Versatile pocket size
- Features four lighting modes: direct beam spotlight and eco, normal and full power flood light modes
- 180° flexible handle with inbuilt super strong magnet



\$49.95

Professional Diamond Tipped Mini Engraver 680004

- Handy pocket engraver easily marks glass, ceramic, plastic and hardened metals
- Long lasting diamond tip
- Suitable for personalising toys, sport equipment, tools, appliances, gifts and trophy's
- Supplied with 2 x AAA batteries



WHILE STOCKS LAST!

\$399.95

Professional Digital Torque Wrench 830200

- Easy to read OLED digital display
- Push-thru ratchet head
- TimeStrip re-calibration indicator
- Rapid push/pull torque adjustment knob
- Rechargeable lithium battery
- 12 different units of Torque measure
- Supplied with USB charging lead
- Calibration certificate included
- **Made in England**



Sq.Dr.	Range Nm	Range lbf.ft	Ratchet Teeth	Length
½"	40 - 200	30 - 150	72	474mm

\$87.95

Professional LED Work Light 300601

Rechargeable 260mm

- Multifunctional work light
- Lighting modes: top light with direct beam and work light with wide flood beam
- Super strong magnets and two 360° rotating hooks
- 180° swivel stand with strong inbuilt magnet



\$140.95

Professional Flood and Area Worklight 300609

Rechargeable

- Multifunctional flood and area light suitable for use in workshops, building, camping an outdoor use
- Adjusts the brightness from 60-1000 Lumens



\$105.95

Professional LED Slimline Work Light 300602

Rechargeable 390mm

- Ultra-bright and lightweight slim work light illuminates hard to reach places with ease
- Lighting modes: top light with direct beam and work light with wide flood beam on adjustable dimmer switch



WHILE STOCKS LAST!

\$25.95

Ball Joint Separator 660490

- Effective and simple ball joint separation and removal
- Durable drop forged steel design enables hammer strike operation
- Suitable for passenger and light commercial applications



\$105.95

Butane Soldering Iron Kit 680005

9 Piece

- Three features in one kit: Soldering Iron, Hot Torch and Hot Blower
- Piezo ignition with adjustable flow and constant flame capability
- Inbuilt stand and child safety latch
- **This kit is not supplied or filled with butane gas**



WHILE STOCKS LAST!

\$649.95

Heavy Duty Torque Wrench 800340

½" Sq. Dr

- Designed for torquing wheel nuts
- Large easy to read dual scale
- Push-thru ratchet head
- Pull out torque adjustment bar
- **Made in England**

Description	Drive Sq. Dr	Range Nm	Range lbf. ft	Ratchet Teeth
Motorq 340	½"	80-340	60-250	60

\$1185.95

Heavy Duty Torque Wrench 800500

¾" Sq. Dr

- 30 tooth **unique engagement** ratchet head provides more precise engagements per revolution
- Operates in both clockwise and anti-clockwise directions (ratchet repair kits available)
- Dual scale micrometre style adjustment (Nm/lbf.ft)
- Manufactured to ISO9000:2000 standard
- **Supplied with calibration certificate**
- **Made in England**

Description	Drive Sq. Dr	Range Nm	Range lbf. ft	Ratchet Teeth
Motorq 500	¾"	300-1000	200-750	36

TOOL SALE



MATSON BATTERY ACCESSORIES · MATSON BATTERY ACCESSORIES · MATSON

\$109.95



Waterproof Battery Chargers AE500E

- One step operation
- Fully automatic charging
- Maintains optimum battery condition
- 5 AMP
- 12 Vdc

\$329.95



6/12/24 Volt Charger IR61224

- Selectable Amp and Voltages
- Electronic touch button control
- Chemistry selectable: GEL, Flooded(SLA, Deep Cycle, AGM), Calcium

\$132.95



Antizap Professional Jumper Leads MA254AZ

- Guaranteed to protect against voltage spikes
- Durable high grade insulation material resists acid, oil and chemicals
- 600 AMP capacity
- 4m length

\$136.95



Dual Battery Kit with Parallel Switch MA98504

- Automatically isolates the starting battery from the auxiliary battery
- Suitable for 4X4, Marine, Truck, Caravan & camping applications
- No need to modify vehicle wiring
- Voltage sensitive relay rated at 140 amps with emergency parallel switch
- Easy to install

WHILE STOCKS LAST!

\$167.95



12V/5V Portable Solar Charger MA1103 14 WATT

- 12V/1A Solar Maintainer
- 5V/2A USB Solar Charger
- Ultra-light
- Compact
- Water Resistant*

• Open Dimensions: 495 x 235 x 2mm

\$59.95



Bluetooth Wireless Technology Battery Monitor MA98415 6-20V

- Suits 12V batteries
- Real-time battery monitoring of up to four devices simultaneously
- Monitors can be combined for 24V, 36V & 48V systems (one monitor required per battery)
- Tests vehicle cranking and charging levels



Home Screen Charging Test Trip Cranking Test

WHILE STOCKS LAST!

\$133.95



Portable USB Solar Charger MA1104 15 WATT

- Ultra-light weight 420g
- 5V, 3 AMP USB 2.0 Outlet
- Compact Panels 2mm Thick
- Water Resistant*
- Charge compatible phones, tablets, power banks etc.

• Open Dimensions: 497 x 250 x 2mm

\$253.95



Terminal Assortment Pack MABTP50 50 Pieces

- Selection of 50 popular terminals and 3 pairs of covers
- See website for full contents list

Part No	Qty	Part No	Qty
MA11	10	MA36STN	5
MA14N	5	MA36STP	5
MA14P	5	MA100N	5
MA32	10	MA100P	5

\$126.95



Memory Saver MS-1E

- Provides power to 12V vehicle computers while charging battery
- Helps preserve computer memory of radio stations, clocks, user settings etc
- Connects via OBD port or cig/accessory socket
- 12V 4.5Ah rechargeable SLA battery

WHILE STOCKS LAST!

\$82.95



Portable USB Solar Charger MA1105 5 WATT

- 5V USB Solar Charger
- Ultra-light
- Compact
- Water Resistant*
- Charges portable devices

• Open Dimensions: 299 x 152 x 2mm

NEW PRODUCT

\$683.95



\$911.95



Power Inverters

- Converts 12VDC to 240VAC
- Pure sine wave output
- Includes power cables
- 1 x USB-C & 1 x USB Outlets
- Multi-function LCD status display

Part No	PURE SINE	PRICE
MAI2001P	2000 WATT	\$683.95
MAI3001P	3000 WATT	\$911.95



BIKESERVICE SPECIALS · BIKESERVICE SPECIALS · BIKESERVICE SPECIALS



Pick & Hook Sets 4 Piece

- Durable soft grip pick and hook set ideal for removal of o-rings, seals and bushes in various mechanical applications
- Contains straight, 45° and 90° picks plus hook tool
- Stainless steel construction
- Ergonomic soft grip handles
- Available in standard and long shaft sets

Part No.	Description	Shaft Length mm	Length mm	PRICE
BS1234	Standard	76	162	\$18.85
BS0230	Long	152	214	\$23.85

WHILE STOCKS LAST!

\$8.95

Wire Retaining Tool

BS1034

- Designed to firmly hold cables, wires and fasteners during removal and replacement
- Net diameter: 20mm
- Cable Length: 450mm



NEW PRODUCT

\$349.95

Spoke Torque Wrench Set

BS70009 Steel 12 Piece

- Enables tightening and removal of spokes in one piece
- Applies correct and equal tension to the spokes
- Spoke remover releases damaged or rusted spokes easily
- Simply tighten the spoke until you hear and feel a click which indicates that the spoke is adjusted correctly
- Takes all the guesswork out of wheel and spoke assembly and maintenance
- Adjustable Torque Wrench 2-10 Nm
- Sizes: 5.0, 5.6, 5.8, 6.0, 6.2, 6.3, 6.5, 6.7, 6.9, 7.1, 7.4mm & Spline drive



\$316.95

Chain Breaking Riveting & Repair Master Kit

BS70002

- Comprehensive tool kit for drive chain replacement and repair
- Provides the ability to break, rivet and press drive chain master links
- Suits: Chain sizes: #415, 420, 428, 520, 525, #30 (50), 532, 630 and 632
- Includes: BS35101 Chain Breaking & Riveting Set
- BS3500 Chain Extractor
- BS3506 Chain Link Pliers
- BS1164 Chain Tensioner Tool



WHILE STOCKS LAST!

\$167.95

Multi-Function Ratchet Wrench Set

BS80056 200mm

- Features six interchangeable ratchet mechanisms
- Includes three universal joints and safety lock extensions in 1/4", 3/8" & 1/2" Sq. Drive



\$90.95

Tyre Pressure Gauge

BS80086

- Robust gauge with protective rubber bumper reading up to 5 bar (70 psi).
- With thread depth measurement.
- Braided steel hose with swivel chuck and pressure release button.



WHILE STOCKS LAST!

\$8.95

Battery Terminal Tool Kit

BS1020 2 Piece

- Quickly and easily remove corrosion and dirt from cable clamps and terminal posts
- Five functions ideal for battery maintenance
- Functions: Pick, SS cleaning brush, scraper, gapper, Phillips screwdriver



WHILE STOCKS LAST!

\$6.95

Anti-Slip Film

BS1035 Roll 10 x 3000mm

- Ideal for brake and clutch levers and luggage resting points
- Adhesive back will stick to most surfaces



WHILE STOCKS LAST!

\$13.95

Pulley Nut Wrench Dual End

BS9853 Size: 14, 17mm

- Used in conjunction with a locking wrench while torquing the pulley nut
- Dual size suits common applications
- Style: 12 Point



TRIDON

PREMIUM QUALITY · EXTENSIVE RANGE · WE'VE GOT IT COVERED.

\$46.95

Black Cable Tie Combo Pack

CTCP10 1000 Piece

- Black cable ties
- All popular sizes

1000 CABLE TIES



\$11.95

Cable Tie Assorted Pack

CTP07 500 Piece

Colour	Length mm	Width mm	Qty
Red	100	2.5	100
Yellow	100	2.5	100
Blue	100	2.5	100
Black	150	2.5	100
Natural	150	2.5	100



\$16.95

CTP32



Cable Tie Combo Packs

Assorted Vibrant Colours 100 Pieces

- Five Vibrant Colours – Blue, Green, Yellow, Pink, Orange

Part No.	Size mm	Qty	PRICE
CTP31	200 x 4.8	100	\$11.95
CTP32	300 x 4.8	100	\$16.95

\$11.95

CTP31



\$45.95

CV Boot Combo Kit

CVCP10 Combo CV Boot

Name	Part No	Qty
CV Boot Clamp	CV2-63130	5
CV Boot Clamp	CV280	10
CV Boot Clamp	CV360	5
CV Boot Clamp	CV480	5
CV Boot Clamp	CV680	5
Banding Cutter	301104	1



\$174.95

Hose Clamp Workshop Pack

CWP150 MH/HS Perforated Band, Part Stainless Steel

- 150 clamps in a carry case
- Clearly marked with size range
- All popular sizes

PART STAINLESS 150 CLAMPS



\$75.95

Sump Plug Workshop Pack

TPP001 23 Pieces

- High quality replacement sump plugs
- Premium quality carbon steel



\$79.95

Rubber Lined Clamp Value Pack

TRLC90K 90 Pieces

- For pipes, cables, groups of cables, hoses etc.
- Handy carry case provides one compact location



RUBBER LINED 90 CLAMPS

TOOL SALE

RENNSTEIG
MADE IN GERMANY

RENNSTEIG SPECIALS · RENNSTEIG SPECIALS · RENNSTEIG SPECIALS · RENNSTEIG SPECIALS



Dual Edge Screw Extractor Sets

- The new generation of screw extractors, tapered flute design (patented)
- High-strength steel for greater resistance to breaking and rounding out
- For unscrewing ruined screws and bolts and damaged threads
- Can be turned into clockwise or counter clockwise direction (for right and left hand threads)

Part No.	Description	PRICE
471 903	3 Piece - Size 1-3 in plastic tube	\$49.99
471 904	5 Piece - Size 1-5 in plastic tube	\$118.00

\$24.00



Trim & Clip Remover

449 250 250mm

- Suitable for removing clips and door trim linings on vehicles
- Slim, ergonomic shape with wooden handle
- PVC powder coating improves sliding performance and avoids damage to sensitive surfaces

\$299.95



Hollow Wad Punch Set

140 901 19 Piece

- For stamping out or producing gaskets and seal rings from materials such as rubber, leather, felt, plastic, cork, fabric or similar components
- Multi-layered wooden boards or polyamide boards should be used as a base impact support for stamping
- Dip-coated lacquered finished with laser engraved etching
- Size Range: 2 - 20mm in increments of 1mm

\$234.00



Parallel Pin Punch Set XXL

425 154 5 Piece

- Contents: 8, 10, 12, 14 and 16mm XXL pin punches with hand grips
- Heat treated for the perfect balance of hardness, strength and durability



Slitting Chisels

- Ideal for chasing, cutting and slitting
- Hardened striking heads mean no splintering or mushrooms head occurs
- Straight and bent (25° for easy access underneath objects)

Part No.	Tip	Length mm	Shaft Size mm	Blade Length mm	PRICE
380 240C	Straight	240	240	26	\$24.00
380 241C	Bent 25°	240	240	26	\$57.98

\$243.50



Metal Working Punch Set

Set 426 017 Interchangeable Tips 17 Piece

- Flexible use through different tools in one set
- Brass inserts suitable for working on sensitive surfaces
- Two-component soft handguard protects from miss hits and reduces hand fatigue from excess vibrations

Contents	Size mm	Contents	Size mm
Pin Punch Insert	3, 4, 5, 6, & 8	Brass Inserts	4, 5, 6, & 8
Taper Punch Insert	3, 4, 5, 6, & 8	Open End Spanner	8 & 10
Centre Punch Insert	4	Two Component Handle	90

\$149.50



ULTIMAX Wrecking Bar Set

270 002 3 Piece

- Forged, quenched and tempered working edges
- Contains sizes: 1000 x 26 x 16mm, 600 x 26 x 16mm, 400 x 20 x 12mm

\$73.95

Parallel Pin Punch Set

457 102 With guide sleeve 8 Piece

- Set of parallel pin punches with guide sleeve in plastic storage case
- Size range: 0.9, 1.4, 1.8, 2.4, 2.8, 3.4, 3.9 & 5.9mm

\$108.00

Chisel & Punch Foam Tray Set

REN03 8 Piece

- Set of eight chisels and punches in EVA foam tray

Description	Size mm	Description	Size mm
Flat Cold Chisel	200	Pin Punch	4
Flat Cold Chisel	300	Pin Punch	6
Centre Punch	6	Pin Punch	8
Pin Punch	3	Pin Punch	10

METRINCH

The 3 in 1 tool that tightens and removes nuts and bolts



\$525.00



Socket & Spanner Set 1/4", 3/8", & 1/2" Sq. Drive
MET-0610 71 Piece

\$149.00



Spanner Set MET-0125 14 Piece

\$48.00



3/8" Sq. Drive Standard Socket Set
MET-0320 12 Piece

One size.



Fits all.



TRIDON ▶

MEGGA TOOL SALE

TOOL SPECIALS · TOOL SPECIALS · TOOL SPECIALS · TOOL SPECIALS · TOOL SP

\$25.95

FAMOUS TOLEDO

Soldering Iron 302102 50Hz 60W

- Ergonomic bakelite handle with rubber grip
- Wattage: 50Hz 60W
- Heat Range: 460-480°C
- Voltage: 240 VAC



\$295.95

FAMOUS TOLEDO

Torque Bar & Deep Socket Set 309512

- Designed to accurately torque wheel nuts to correct specifications
- Thin wall with protective Polypropylene sleeve ensures wheel surface is damage free
- Socket sizes: 17, 19, 21, 22mm
- Torque bar rating: 65, 80, 100, 120ft. lbs (88, 108, 135, 160Nm)



\$110.95

FAMOUS TOLEDO

Brake & Tyre Measuring Tool 310019

- Measures brake disc and brake pad thickness including tyre tread wear
- Suitable for passenger, 4WD and light trucks
- Stoppers to record readings
- Manufactured from high grade aluminium for long service life



\$253.95

FAMOUS TOLEDO

Universal Lock Nut Removal Kit 309250

- Designed for removing wheel lock nuts on most factory and aftermarket wheels without causing damage
- Conical shaped design allows sockets to fit firmly over the lock nuts
- Heavy duty construction for strength and durability
- Size range from (conical socket): Ø19.4, 20.4, 21.4, 22.4, 23.4, 24.4, 25.4, 27.8, 28.8, 29.8mm



\$167.95

FAMOUS TOLEDO

Low Profile Drain Pan 305089 20L

- Suitable for automotive fluids such as engine oil, coolant, brake fluid, transmission oil, petrol and diesel fuel, etc
- Suitable height for work under motorcycles and ATV's
- Recessed castors provide easy mobility and transportation
- Dimensions: 850 x 600 x 125mm

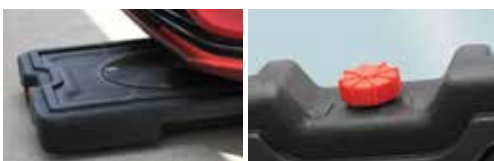

\$60.00

RENNSTEIG

Flat Cold Chisel Set RCC3 3 Piece

- Flat cold chisels in durable fabric wallet
- Forged from highest quality hardened steel
- Contains sizes: 150, 200 and 250mm chisels
- Made in Germany



\$99.00

KNIPEX

Ergostrip Universal Dismantling Tool 16 95 01

- For the fast and precise dismantling and stripping of all common round and damp-proof installation cables (e.g. NYM cable 3 x 1.5 mm² up to 5 x 2.5 mm²), data cable (e.g. twisted pair) and coax cable
- Innovative, ergonomic pistol grip design for easy cutting, stripping and longitudinal cut of the sheath
- Stripping device for cross-sections 0.2; 0.3; 0.8; 1.5; 2.5 and 4 mm²
- Easy insertion of coax and data cable thanks to opening aid
- Made in Germany



\$25.95

MATSON

LED Battery Voltmeter MALED01

- Low wattage and power saving
- Display the voltage of your batteries
- 95cm cable length with cigarette plug
- Display flashes low voltage warning below 11.5V



\$43.50

KNIPEX

Wire Stripping Tool 16 60 06 For coax and data cable

- For stripping outer sheath, shield and insulation in a single process
- Adjustable stripping blade for data cable
- Two blades for cutting and stripping telephone ribbon cable in one operation
- Integrated blade for cutting data cables
- Made in Germany



\$146.00

KNIPEX

Compression Tool 97 40 20

- For crimping F, BNC and RCA connectors
- Robust design
- Suitable for RG 59/6/11 cable
- Rotatable head for different cable sizes
- Rotatable insert for various types of connector
- Made in Germany



NEW PRODUCT

\$299.00

KNIPEX

Electrical Installation Set 00 31 30 BK V01

- This set equips the electrical trade for practically every day-to-day work
- Contains: Ergostrip Universal Stripping Tool 16 95 01, 1000V Diagonal Cutter 70 06 160, 1000V Pliers for Electrical Installation 13 86 200
- Made in Germany



\$93.85

KNIPEX

Automatic Insulation Stripper 12 62 180

- Adjusts automatically to most cable types, with fine adjustment for special materials
- Strips cable with standard materials without any need for manual adjustment
- For single, multiple and fine standard cables of 0.2 -6mm² with standard insulation
- Made in Germany



\$240.00

KNIPEX

Automatic Insulation Stripper 12 42 195 Multistrip 10

- Stripping without re-adjustment from 0.03 to 10.0mm²
- Recessed wire cutter
- Universal blade geometry - robust and more durable
- Ideal grip design with excellent haptics
- Made in Germany



0438-21 . Prices valid 1 October to 31 December 2021. Prices include GST. Please refer to the relevant Tridon catalogues for more comprehensive product information. As participating stores are independent businesses, they reserve the right to set their own selling prices. Pricing throughout this publication is the recommended trade price and may vary from store to store. Every effort has been made to ensure stocks are available at the time of printing. Should any item not be in stock on placement of orders, stores will endeavour to procure those published items. Product images are for illustration purposes only. Produced by Tridon Australia Pty Ltd ACN 001 398 698 ABN 90 001 398 698

TRIDON ▶

1 OCTOBER - 31 DECEMBER 2021 · ONLY WHILE STOCKS LAST · ALL PRICES INCLUDE GST